



**WAKE UP
YOUR PRODUCT.**
PLV CREATE, AMBIENT & PLACEMENT

Pies y banderolas

Banderola **brillo**

Ref.	Medidas	Mat.		
10010700100	A5	PVC TTE	50	50 u
10010700200	A6	PVC TTE	50	50 u

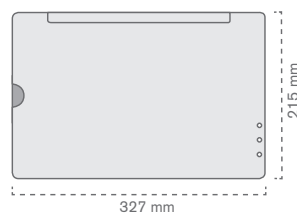

Ref.	Medidas	Mat.		
10010700300	A4	PVC TTE	25	25 u

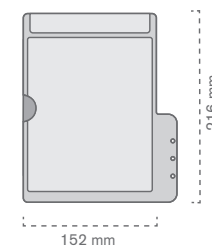

Ref.	Medidas	Mat.		
10010700400	152 x 216 mm	PVC TTE	50	1000 u*

*Pedido mínimo en serigrafía. Para impresión digital pedido min. de 250 uds.

Banderola mate

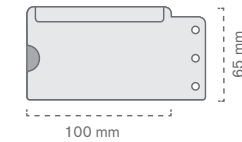
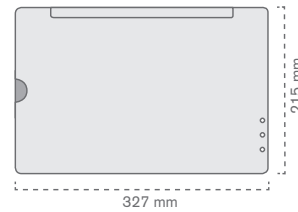
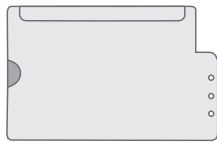

Ref.	Medidas	Mat.		
10010700500	A5	PVC TTE	50	50 u
10010700600	A6	PVC TTE	50	50 u

Ref.	Medidas	Mat.		
10010700700	A4	PVC TTE	25	25 u

Ref.	Medidas	Mat.		
10010700800	100 x 65 mm	PVC TTE	100	100 u

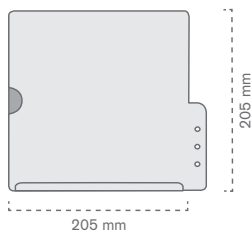
Banderola **mate**

Ref.	Medidas	Mat.		
10010700900	205 x 205 mm	PVC TTE	50	50 u

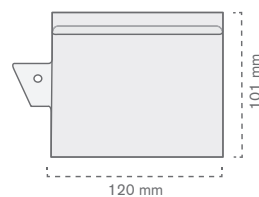
Banderola **stopper** para pinza

Ref.	Medidas	Mat.		
10010701000	120 x 101 mm	PVC TTE	100	100 u

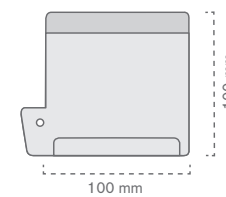
Banderola stopper **personalizable** para pinza

Ref.	Medidas	Mat.		
10010701100	100 x 100 mm	PVC TTE	100	1000 u*

*Pedido mínimo en serigrafía. Para impresión digital pedido min. de 250 uds.

Pie para balda

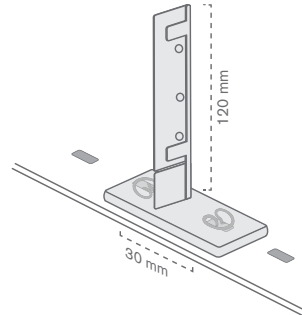

Ref.	Medidas	Color		
10010701200	48 x 25 x 120 mm	TTE	50	100 u

Pie 30 mm. con clips.
Pie de banderola para baldas con orificios de 30 mm. de distancia.

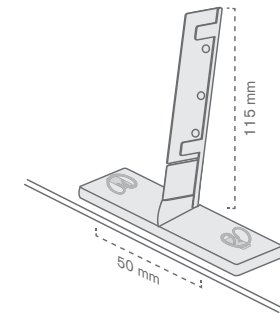

Ref.	Medidas	Color		
10010701400	75 x 25 x 115 mm	TTE	100	100 u

Pie inclinado con clips.
Pie de banderola inclinado para baldas con orificios de 50 mm. de distancia.

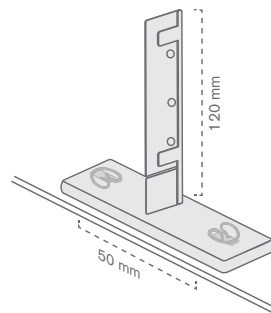

Ref.	Medidas	Color		
10010701300	75 x 25 x 120 mm	TTE	50	100 u

Pie 50 mm. con clips.
Pie de banderola para baldas con orificios de 50 mm. de distancia.

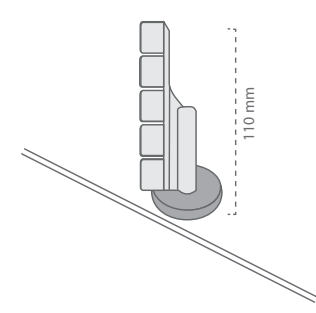

Ref.	Medidas	Color		
10010701500	40 x 40 x 110 mm	TTE	20	20 u

Pie imantado.
Pie de base imantada, ideal para la colocación de banderolas sobre baldas metálicas.

Pie para perfil de etiqueta electrónica

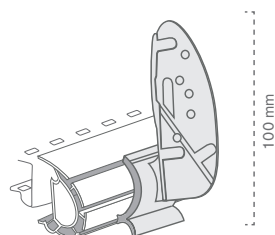

Ref.	Medidas	Color		
10010701600	20 x 40 x 100 mm	TTE	100	100 u

Pie para perfil FL.
Modelo de pie para banderola especialmente diseñado para perfilera FL.

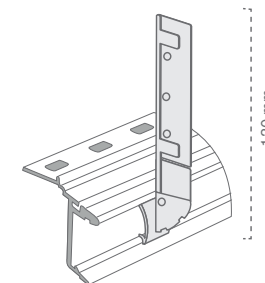
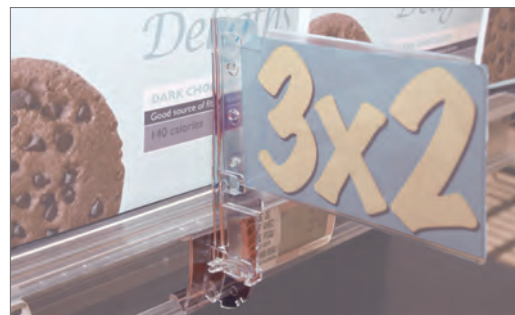

Ref.	Medidas	Color		
10010701800	23 x 45 x 130 mm	TTE	100	100 u

Pie para perfil ETE.
Modelo de pie para banderola especialmente diseñado para perfilera ETE.

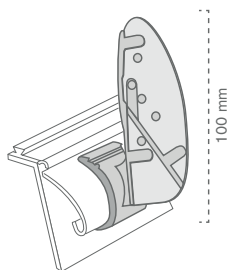

Ref.	Medidas	Color		
10010701700	20 x 50 x 100 mm	TTE	100	100 u

Pie para perfil SlimLine.
Modelo de pie para banderola especialmente diseñado para perfilera SlimLine.

