

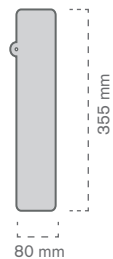

**WAKE UP
YOUR PRODUCT.**
PLV CREATE, AMBIENT & PLACEMENT

Delimitadores verticales

Delimitador vertical estándar



Ref.	Medidas	Mat.		
10011000100	80 x 355 mm	PVC	100	1000 u*

*Pedido mínimo en serigrafía. Para impresión digital el pedido mínimo es de 14 uds.

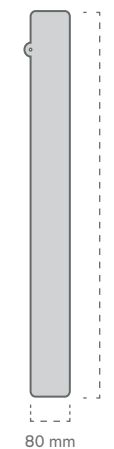

Ref.	Medidas	Mat.		
10011000200	80 x 680 mm	PVC	100	1000 u*

*Pedido mínimo en serigrafía. Para impresión digital el pedido mínimo es de 6 uds.

Delimitador vertical estándar

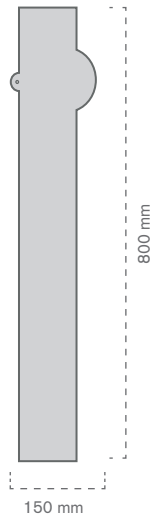

Ref.	Medidas	Mat.		
10011000300	150 x 800 mm	PVC	50	1000 u*

*Pedido mínimo en serigrafía. Para impresión digital el pedido mínimo es de 4 uds.

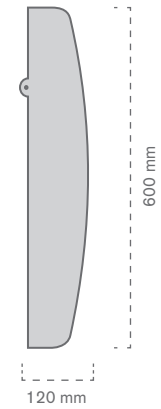

Ref.	Medidas	Mat.		
10011000400	120 x 600 mm	PVC	100	1000 u*

*Pedido mínimo en serigrafía. Para impresión digital el pedido mínimo es de 7 uds.

Delimitador vertical estándar

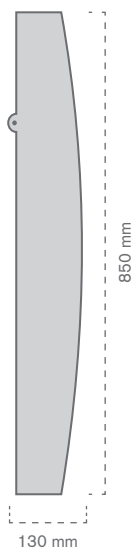

Ref.	Medidas	Mat.		
10011000500	130 x 850 mm	PVC	50	1000 u*

*Pedido mínimo en serigrafía. Para impresión digital el pedido mínimo es de 4 uds.

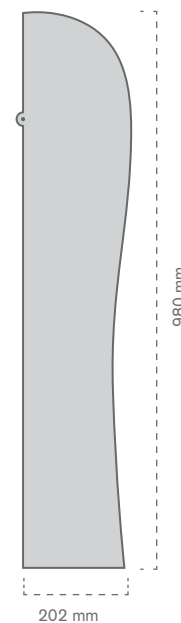

Ref.	Medidas	Mat.		
10011000600	202 x 980 mm	PVC	50	1000 u*

*Pedido mínimo en serigrafía. Para impresión digital el pedido mínimo es de 3 uds.

Delimitador vertical estándar

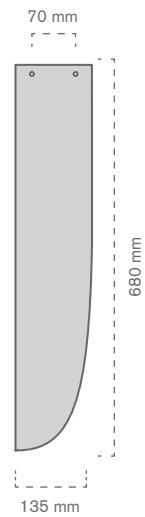

Ref.	Medidas	Mat.		
10011000700	135 x 680 mm	PVC	100	1000 u*

*Pedido mínimo en serigrafía. Para impresión digital el pedido mínimo es de 7 uds.

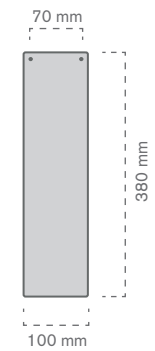

Ref.	Medidas	Mat.		
10011000800	100 x 380 mm	PVC	100	1000 u*

*Pedido mínimo en serigrafía. Para impresión digital el pedido mínimo es de 14 uds.

Delimitador vertical estándar

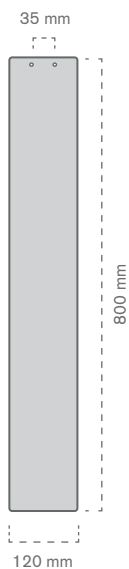

Ref.	Medidas	Mat.		
10011000900	120 x 800 mm	PVC Espumado (3 mm)	50	50 u

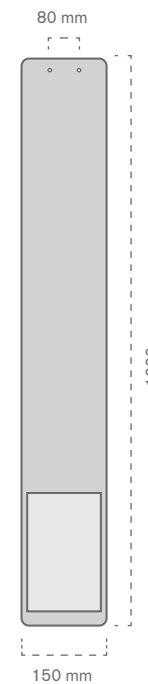

Ref.	Medidas		Mat.		
	Delimitador	Display			
10011001000	150 x 1000 mm	A5	PVC Espumado (3 mm)	40	40 u

Delimitador vertical con stopper

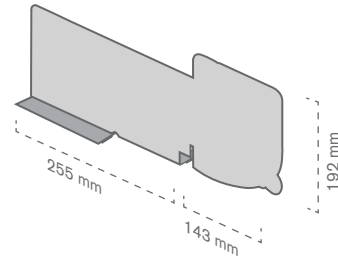

Delimitador vertical con stopper provisto de una doble pestaña imantada en su base que facilita su fijación al lineal.

Ref.	Medidas		Mat.	🛒	📄
	Separador	Stopper			
10011001100	255 x 150 mm	143 x 192 mm	PVC	100	1000 u*

*Pedido mínimo en serigrafía. Para impresión digital el pedido mínimo es de 6 uds.

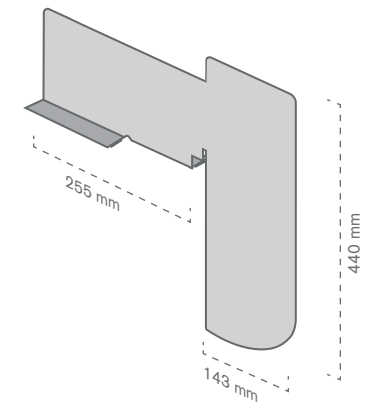

Modelo de delimitador vertical con stopper alargado que, al igual que el modelo anterior, incorpora una doble pestaña imantada en su base que facilita su fijación al lineal.

Ref.	Medidas		Mat.	🛒	📄
	Separador	Stopper			
10011001200	255 x 150 mm	143 x 440 mm	PVC	100	1000 u*

*Pedido mínimo en serigrafía. Para impresión digital el pedido mínimo es de 4 uds.

Delimitador vertical con **stopper**

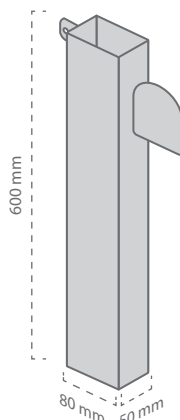

Delimitador vertical 3D con stopper. Este modelo incorpora una pestaña en su parte trasera que facilita su sujeción al lineal por medio de pinzas perforadas para stopper.

Ref.	Medidas		Mat.		
	Delimitador	Stopper			
10011001300	50 x 80 x 600 mm	100 x 110 mm	PVC	25	25 u

Delimitador vertical **compuesto**

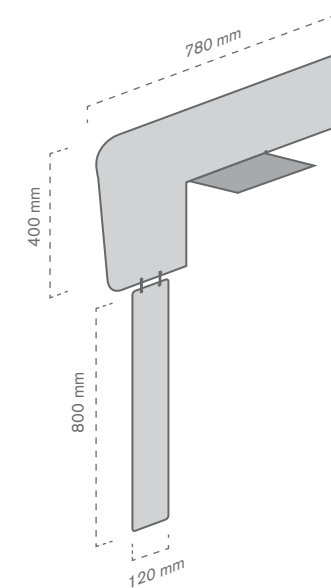

Delimitador vertical compuesto por dos piezas unidas por anillas. Este delimitador cuenta con una doble pestaña imantada que facilita su fijación a la balda.

Ref.	Medidas		Mat.		
	Superior	Inferior			
10011001400	780 x 400 mm	120 x 800 mm	PVC Espumado (3 mm)	25	25 u

Elementos de sujeción

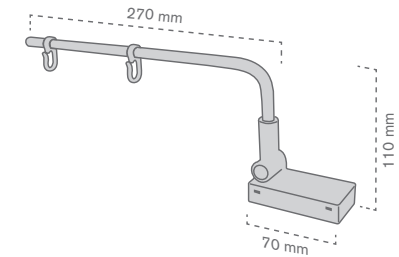
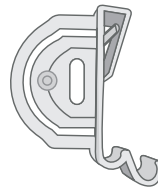

Ref.	Medidas	Mat.		
10050101200	35 x 51 mm	PP Translúcido	100	100 u

Pinza stopper perforada.
Eficaz para la fijación de stoppers y delimitadores a la periferia del lineal.

Ref.	Medidas		
10050300700	340 x 110 mm	10	10 u

Soporte en L imantado.
Sopote imantado especialmente indicado para la fijación de delimitadores verticales a baldas metálicas.

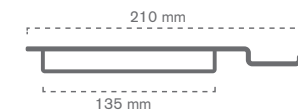
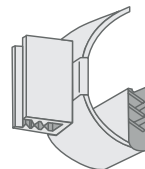
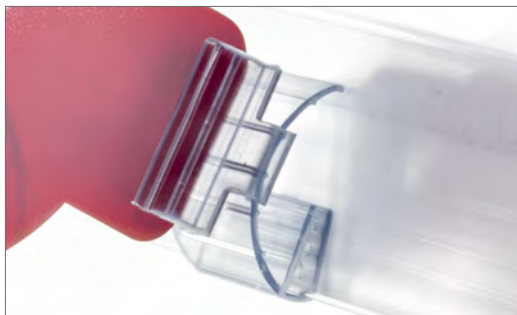

Ref.	Medidas	Mat.		
10050101300	45 x 51 mm	PVC TTE	100	100 u

Pinza stopper regulable.
Modelo regulable que permite adaptar la altura y colocación del stopper en el perfil.

Ref.	Medidas	Mat.	Color		
10011001700	210 x 33 x 20 mm	Metal	NEGRO	10	10 u

Enganche metálico.
Enganche metálico dentado, eficaz para fijar delimitadores verticales a la balda.

