



**WAKE UP
YOUR PRODUCT.**
PLV CREATE, AMBIENT & PLACEMENT



Expositores de producto

242 Expositores de producto

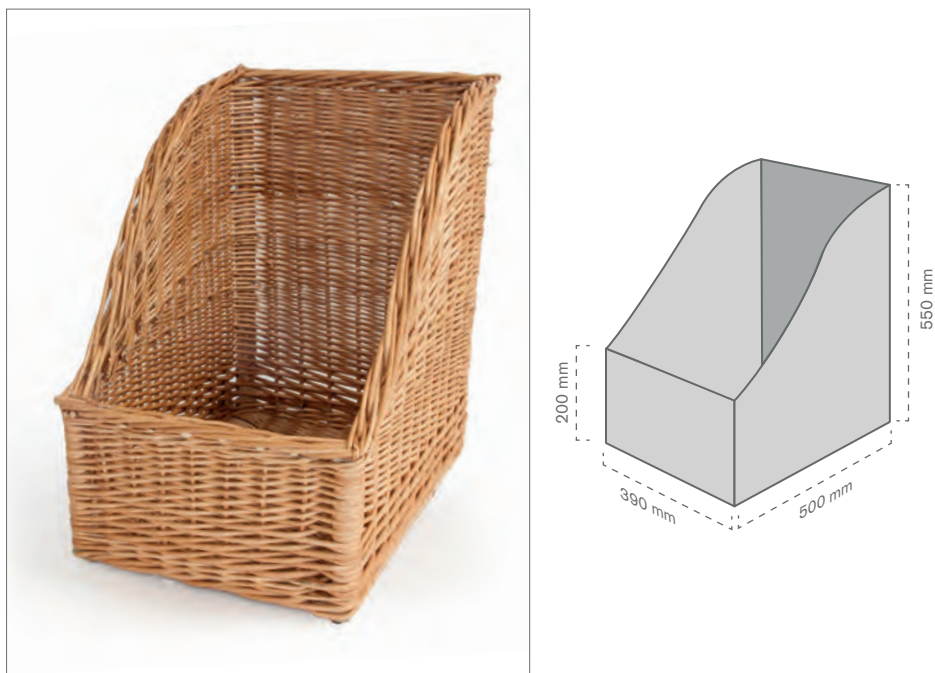
Cesta de mimbre modelo XL



Cesta de mimbre natural con cuña tamaño XL. Ideal para la exposición en hostelería, dando un toque rústico y artesanal al producto.

Ref.	Medidas	Mat.		
10040500100	390 x 500 x 550 mm	Mimbre	1	1 u

Cesta de mimbre modelo L

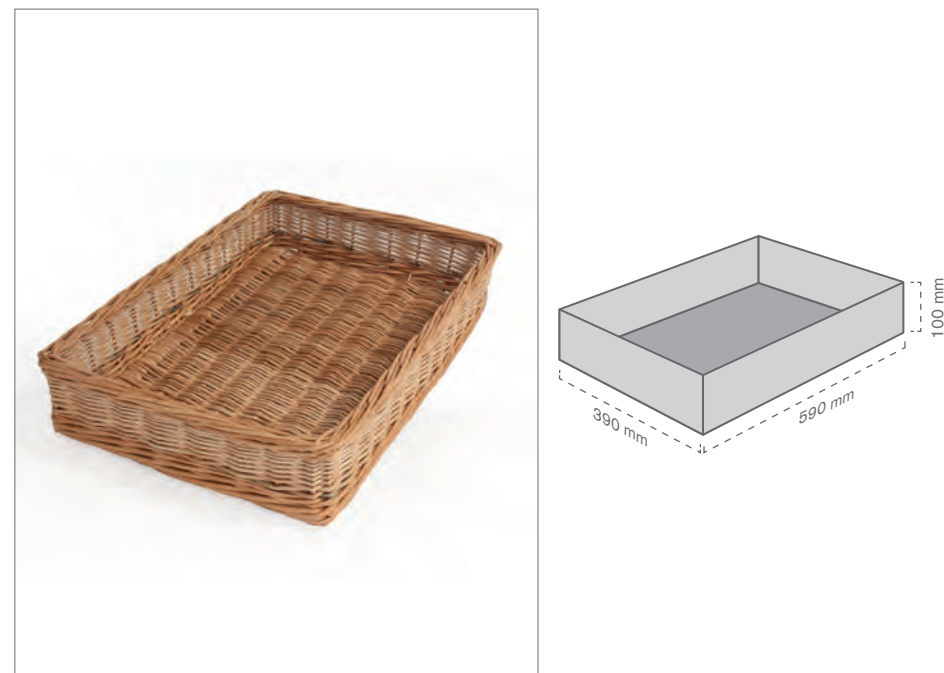



Cesta de mimbre natural tamaño L. Ideal para la exposición en hostelería, dando un toque rústico y artesanal al producto.

Ref.	Medidas	Mat.		
10040500200	390 x 590 x 100 mm	Mimbre	5	5 u

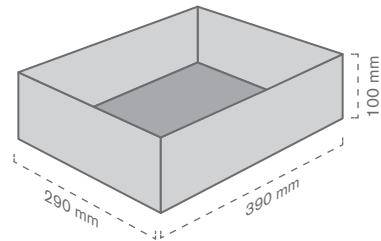
Cesta de mimbre modelo M



Cesta de mimbre natural tamaño M. Ideal para la exposición en hostelería, dando un toque rústico y artesanal al producto.

Ref.	Medidas	Mat.		
10040500300	290 x 390 x 100 mm	Mimbre	5	5 u

Cesta de mimbre con cuña modelo M

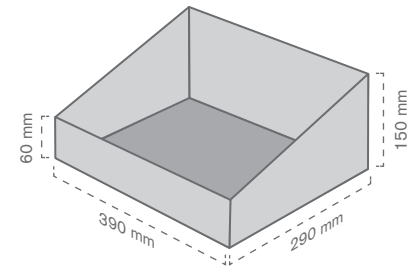

Cesta de mimbre natural con cuña tamaño M. Ideal para la exposición en hostelería, dando un toque rústico y artesanal al producto.

Ref.	Medidas	Mat.		
10040500400	390 x 290 x 150 mm	Mimbre	5	5 u

244 Expositores de producto

Expositor de **degustación Aries**



Expositor de degustación diseñado para secciones de charcutería, productos gourmet y/o frutería indistintamente. Incluye servilletero, palillero y papelera.

Ref.	Medidas	Mat.	Color		
10040500600	350 x 350 x 1315 mm	Metal	NEGRO	1	1 u

Expositor de **cúpulas Aquarius**

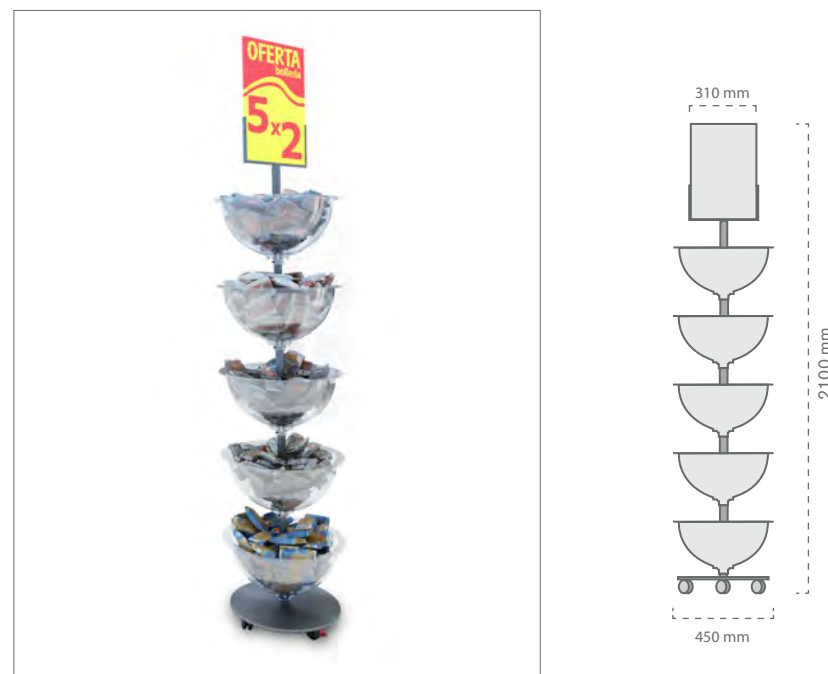

Expositor de producto a granel. Su estructura compuesta por diversas cúpulas permite la disposición de diversos artículos a granel. Las cúpulas son regulables en altura, permitiendo adaptar su posición.

Ref.	Medidas	Mat.	Color		
10040501700	450 x 450 x 2100 mm	Metal	NEGRO	1	1 u

Expositor de venta cruzada Taurus

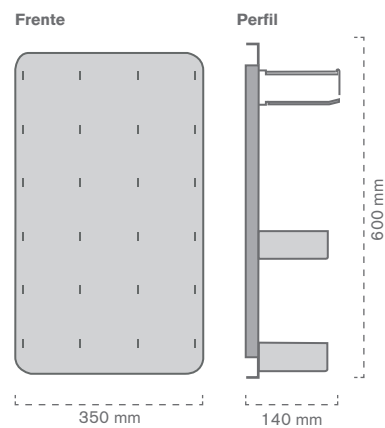

Expositor de venta cruzada adaptable a cabeceras promocionales, pared, columnas de pasillo o línea de cajas. Incorpora ranuras en su panel trasero para reubicar sus accesorios portaproducto.



Ref.	Medidas	Mat.	Color		
10040501600	350 x 140 x 600 mm	Metal	NEGRO	1	1 u

Disponible en otros colores bajo pedido.

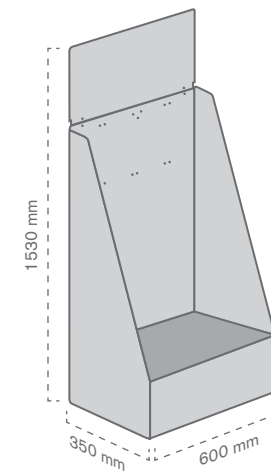
Expositor ECO Bags



Expositor de polipropileno, especialmente indicado para la exposición de bolsas ecológicas en el punto de venta.

Ref.	Medidas	Mat.		
10040501500	600 x 350 x 1530 mm	PP Celular (5 mm)	1	1 u

246 Expositores de producto

Expositor de **pequeño dispositivo**

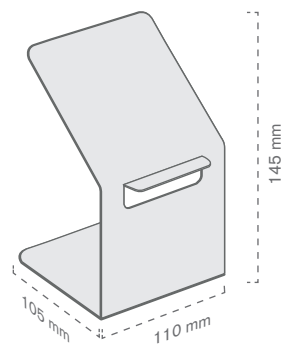

Expositor de pequeño producto, especialmente indicado para la exhibición de pequeños electrodomésticos como radios, despertadores, móviles y relojes, entre otras cosas.

Ref.	Medidas	Mat.		
10040501800	110 x 105 x 145 mm	PMMA TTE (3 mm)	6	12 u

Expositor de **pequeño dispositivo**



NEW

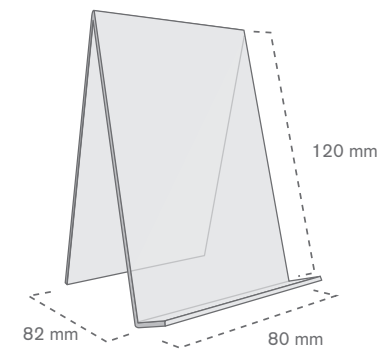

Expositor de pequeño producto, especialmente indicado para la exhibición de smartphone o tablet

Ref.	Medidas	Mat.		
10040509800	80 x 82 x 120 mm	PMMA TTE (3 mm)	6	12 u

Expositor de pequeño dispositivo

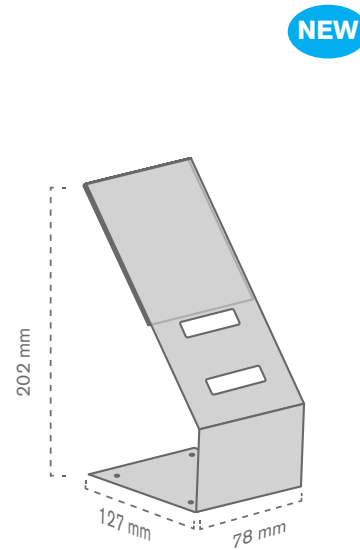

Expositor de pequeño producto, especialmente indicado para la exhibición de relojes y pulsómetros.

Ref.	Medidas	Mat.		
10040509700	78 x 127 x 202 mm	PMMA TTE (3 mm)	10	10 u

Expositor de pequeño producto para lineal

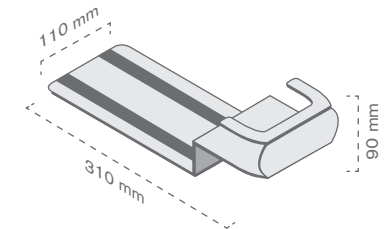

Expositor imantado diseñado para la exhibición de productos en el punto de venta. Su material lo convierte en un elemento resistente, siendo posible la personalización de su parte frontal por medio de vinilo.

Ref.	Medidas	Mat.		
10040504000	110 x 310 x 90 mm	PMMA TTE (3 mm)	10	10 u

Diseño no incluido.

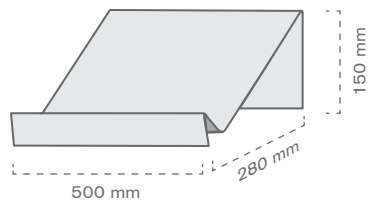
Expositor **inclinado**

Expositor de metacrilato especialmente indicado para inclinar los productos ubicados en las baldas inferiores, permitiendo así una visibilidad del producto adecuada y favorable.

Ref.	Medidas	Mat.		
10040504100	500 x 280 x 150 mm	PMMA TTE (5 mm)	6	6 u

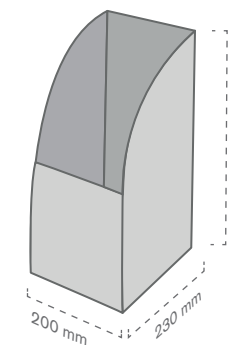
Expositor **Slim box**

Expositor contenedor de producto. Este modelo está diseñado para recoger y exhibir productos, especialmente aquellos que poseen una forma alargada, facilitando así la organización en tienda.

Ref.	Medidas	Mat.		
10040504200	200 x 230 x 500 mm	PP Celular (3,5 mm)	5	5 u

Pódium

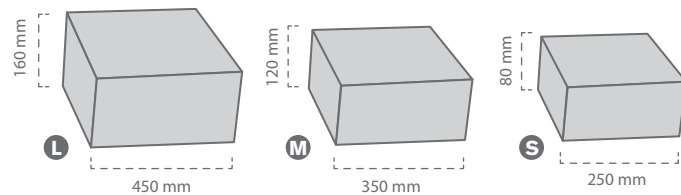

Mod.	Ref.	Medidas	Mat.	Color	🛒	📄
L	10040502800	450 x 450 x 160 mm	Metal	NEGRO	1	1 u
M	10040503100	350 x 350 x 120 mm	Metal	NEGRO	1	1 u
S	10040503400	250 x 250 x 80 mm	Metal	NEGRO	1	1 u

Expositor Puente

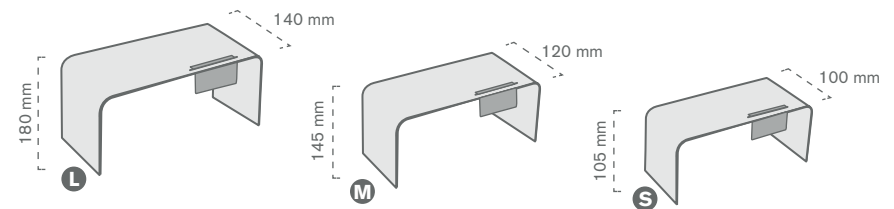

Mod.	Ref.	Medidas		Mat.	Color	🛒	📄
		Expositor	Portaprecio				
L	10040501900	290 x 140 x 180 mm	53 x 37 mm	PMMA (5 mm)	TTE	4	4 u
L	10040502100	290 x 140 x 180 mm	53 x 37 mm	PMMA (5 mm)	BCO	4	4 u
M	10040502200	255 x 120 x 145 mm	53 x 37 mm	PMMA (5 mm)	TTE	4	4 u
M	10040502400	255 x 120 x 145 mm	53 x 37 mm	PMMA (5 mm)	BCO	4	4 u
S	10040502500	220 x 100 x 105 mm	53 x 37 mm	PMMA (5 mm)	TTE	4	4 u
S	10040502700	220 x 100 x 105 mm	53 x 37 mm	PMMA (5 mm)	BCO	4	4 u

Disponible en otros colores bajo pedido.

250 Expositores de producto

Expositor **Puente**



NEW

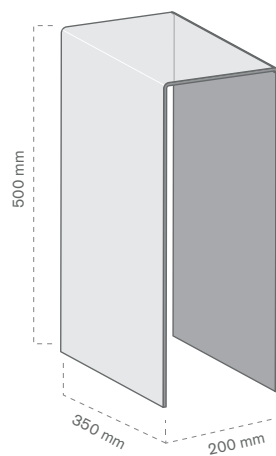

Ref.	Medidas	Mat.	Color		
10040509900	500 x 350 x 200 mm	PMMA (5 mm)	TTE	4	4 u

Expositor **Puente**



NEW

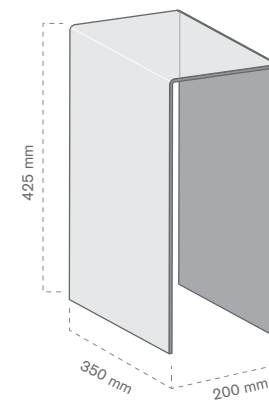

Ref.	Medidas	Mat.	Color		
10040510000	450 x 350 x 200 mm	PMMA (5 mm)	TTE	4	4 u

Expositor modular **Professional**

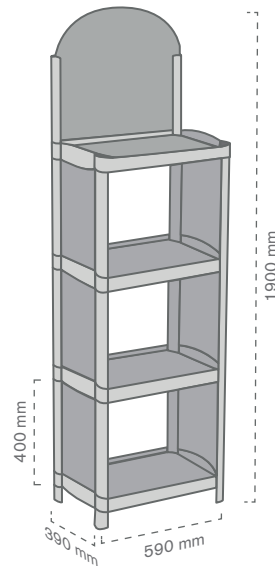

Consta de tres módulos, sirviendo de estantería para la organización y disposición de producto en tienda. Además, admite la personalización de su parte superior y lateral. Aguanta entre 30-35 kg. por balda.

Ref.	Medidas	Mat.	Color		
10040506800	590 x 390 x 1900 mm	PS/ABS	ROJO	1	1 u
10040506900	590 x 390 x 1900 mm	PS/ABS	NEGRO	1	1 u
10040507000	590 x 390 x 1900 mm	PS/ABS	BCO	1	1 u
Ref.	Descripción	Mat.	Color		
10040507600	Personalización	PVC espumado	BCO	1	1 u

Expositor modular **Desk Promoter**

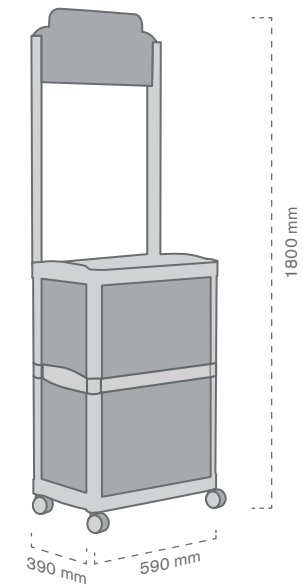

Expositor móvil que puede ser utilizado a modo de mesa en el punto de venta. Este modelo admite la personalización de su parte frontal y lateral, aguantando entre 30-35 kg. por balda.



Ref.	Medidas	Mat.	Color		
10040507100	590 x 390 x 1800 mm	PS/ABS	NEGRO	1	1 u
10040507200	590 x 390 x 1800 mm	PS/ABS	BCO	1	1 u
Ref.	Descripción	Mat.	Color		
10040507600	Personalización	PVC espumado	BCO	1	1 u

252 Expositores de producto

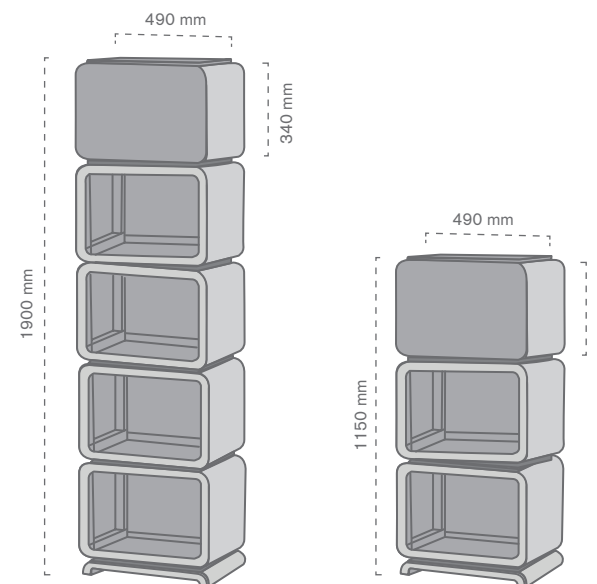
Expositor modular **Smarttower**



Expositor automontable. Este modelo se adapta a todo tipo de necesidades, siendo posible utilizarlo como mesa o expositor. Su composición es personalizable, aguantando hasta 25 kg. por balda (sin girar). Cada módulo mide 490 x 326 x 340 mm. La versión de 3 módulos incluye una bandeja colocada en la parte superior.

Ref.	Mat.	Módulos	Color		
10040505500	PS/ABS	3	BCO	1	1 u
10040505600	PS/ABS	3	NEGRO	1	1 u
10040505900	PS/ABS	5	BCO	1	1 u
10040506000	PS/ABS	5	NEGRO	1	1 u

Accesorios para expositor modular **Smartower**



Con estos accesorios podrás decorar, dar forma y luz a tu expositor.
 A: Bandeja / B: Panel decorativo / C: Vinilo rotulado / D: Porta-lámparas

Ref.	Medidas	Mat.	Color		
A 10040506500	420 x 300 x 20 mm	PS/ABS	BCO	1	1 u
A 10040506600	420 x 300 x 20 mm	PS/ABS	NEGRO	1	1 u
B 10040507300	483 x 323 x 2 mm	PVC Espumado	BCO	1	1 u
B 10040507400	483 x 323 x 1 mm	PET-G	BCO	1	1 u
C 10040508400	340 x 300 mm (X2)	Vinilo	BCO	1	1 u
D 10040506700	483 x 323 x 2 mm	PVC Espumado	BCO	1	1 u

Expositor **Box**

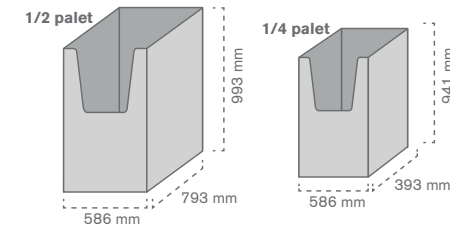

Color*/Referencia				Medidas	Mat.		
186 C	347 C	BCO	NEGRO				
10040500700	10040500800	10040500900	10040501000	586 x 793 x 993 mm	PP Celular (3,5 mm)	2	2 u
10040501100	10040501200	10040501300	10040501400	586 x 393 x 941 mm	PP Celular (3,5 mm)	2	2 u

