

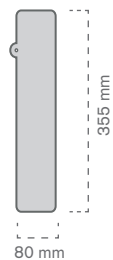

**WAKE UP  
YOUR PRODUCT.**  
PLV CREATE, AMBIENT & PLACEMENT

# Delimitadores verticais

Delimitador vertical **standard**

Ref.	Medidas	Mat.		
10011000100	80 x 355 mm	PVC	100	1000 u*

\*Pedido mínimo em serigrafia. Para impressão digital o pedido mínimo é de 14 und.

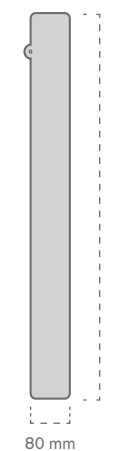

Ref.	Medidas	Mat.		
10011000200	80 x 680 mm	PVC	100	1000 u*

\*Pedido mínimo em serigrafia. Para impressão digital o pedido mínimo é de 6 und.

## Delimitador vertical **standard**

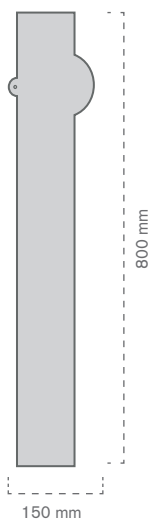

Ref.	Medidas	Mat.		
10011000300	150 x 800 mm	PVC	50	1000 u*

\*Pedido mínimo em serigrafia. Para impressão digital o pedido mínimo é de 4 und.

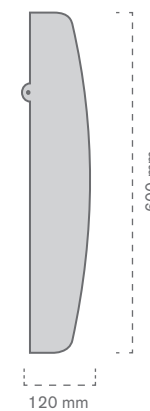

Ref.	Medidas	Mat.		
10011000400	120 x 600 mm	PVC	100	1000 u*

\*Pedido mínimo em serigrafia. Para impressão digital o pedido mínimo é de 7 und.

Delimitador vertical **standard**

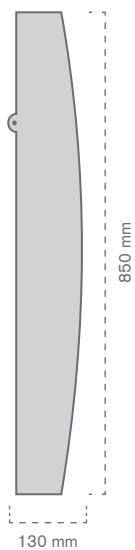

Ref.	Medidas	Mat.		
10011000500	130 x 850 mm	PVC	50	1000 u*

\*Pedido mínimo em serigrafia. Para impressão digital o pedido mínimo é de 4 und.

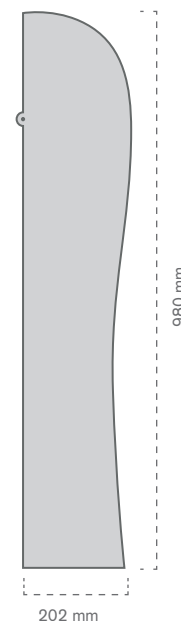

Ref.	Medidas	Mat.		
10011000600	202 x 980 mm	PVC	50	1000 u*

\*Pedido mínimo em serigrafia. Para impressão digital o pedido mínimo é de 3 und.

## Delimitador vertical **standard**

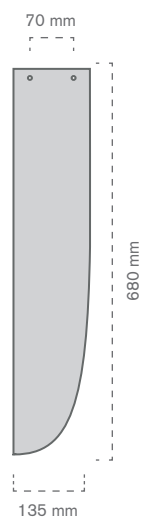

Ref.	Medidas	Mat.		
10011000700	135 x 680 mm	PVC	100	1000 u*

\*Pedido mínimo em serigrafia. Para impressão digital o pedido mínimo é de 7 und.

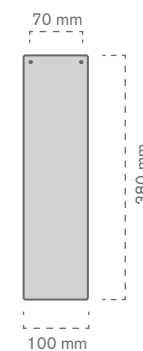

Ref.	Medidas	Mat.		
10011000800	100 x 380 mm	PVC	100	1000 u*

\*Pedido mínimo em serigrafia. Para impressão digital o pedido mínimo é de 14 und.

Delimitador vertical **standard**

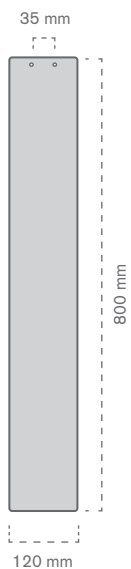

Ref.	Medidas	Mat.		
10011000900	120 x 800 mm	PVC Espumado (3 mm)	50	50 u

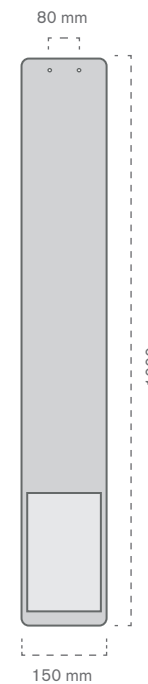

Ref.	Medidas		Mat.		
	Delimitador	Display			
10011001000	150 x 1000 mm	A5	PVC Espumado (3 mm)	40	40 u

## Delimitador vertical com stopper

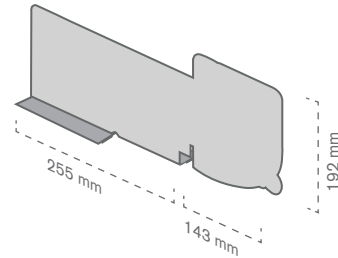

Delimitador vertical com stopper provido de uma aba dupla com ímã na sua base que facilita a sua fixação ao linear.

Ref.	Medidas		Mat.	🛒	📄
	Separador	Stopper			
10011001100	255 x 150 mm	143 x 192 mm	PVC	100	1000 u*

\*Pedido mínimo em serigrafia. Para impressão digital o pedido mínimo é de 6 und.

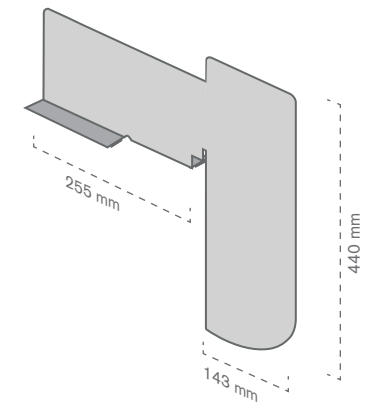

Modelo de delimitador vertical com stopper alargado que, igual ao modelo anterior, incorpora uma aba dupla com ímã na base que facilita a fixação no linear.

Ref.	Medidas		Mat.	🛒	📄
	Separador	Stopper			
10011001200	255 x 150 mm	143 x 440 mm	PVC	100	1000 u*

\*Pedido mínimo em serigrafia. Para impressão digital o pedido mínimo é de 4 und.

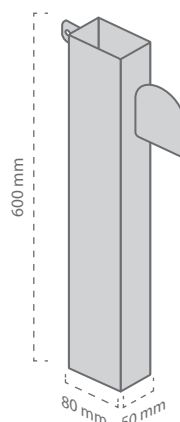
Delimitador vertical com **stopper**

Delimitador vertical 3D com stopper. Este modelo incorpora uma aba na parte traseira que facilita a colocação no linear com pinças perfuradas para stopper.

Ref.	Medidas		Mat.		
	Delimitador	Stopper			
10011001300	50 x 80 x 600 mm	100 x 110 mm	PVC	25	25 u

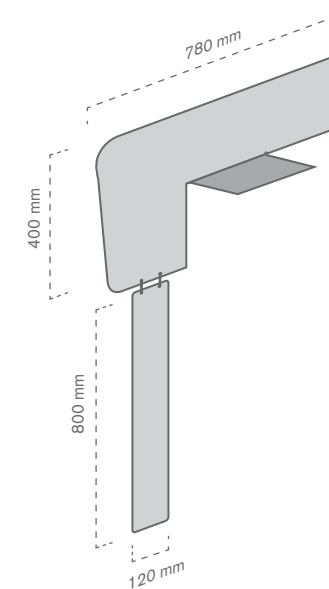
Delimitador vertical **composto**

Delimitador vertical composto por duas peças unidas por anilhas. Este delimitador tem uma dupla aba com ímã na base que facilita a fixação do produto na prateleira.

Ref.	Medidas		Mat.		
	Superior	Inferior			
10011001400	780 x 400 mm	120 x 800 mm	PVC Espumado (3 mm)	25	25 u



## Elementos de fixação

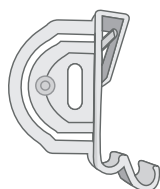

Ref.	Medidas	Mat.		
10050101200	35 x 51 mm	PP Translúcido	100	100 u

**Pinça stopper perfurada.**  
Eficaz para a fixação de stoppers e delimitadores aos perfis do linear.

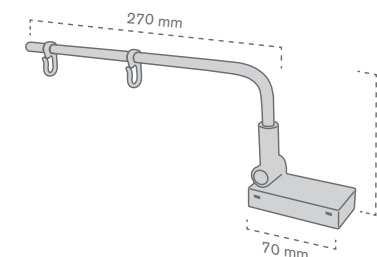

Ref.	Medidas		
10050300700	340 x 110 mm	10	10 u

**Suporte em L com íman.**  
Suporte com íman especialmente indicado para a fixação de delimitadores verticais em prateleiras metálicas.

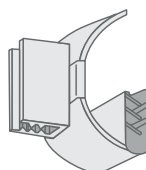
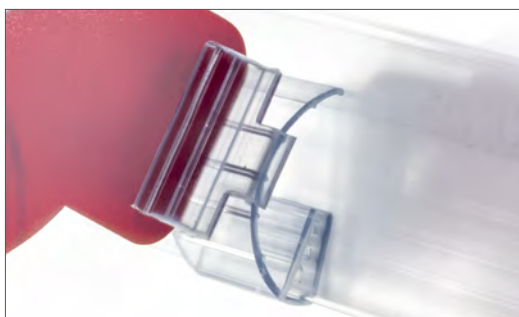

Ref.	Medidas	Mat.		
10050101300	45 x 51 mm	PVC TTE	100	100 u

**Pinça stopper regulável.**  
Modelo regulável que permite adaptar a altura e a colocação do stopper no perfil.

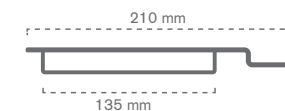

Ref.	Medidas	Mat.	Cor		
10011001700	210 x 33 x 20 mm	Metal	<b>PRETO</b>	10	10 u

**Encaixe metálico.**  
Encaixe metálico dentado, eficaz para fixar delimitadores verticais à prateleira.

