



**WAKE UP
YOUR PRODUCT.**
PLV CREATE, AMBIENT & PLACEMENT



Segmentadores

190 Segmentadores

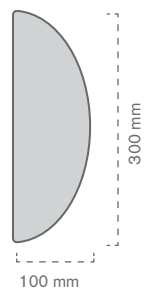
Segmentador para arca vertical



Segmentador de arca vertical disponível em diferentes materiais, segundo necessidades. Este modelo admite a personalização de desenho e texto através de impressão digital.

Ref.	Medidas	Mat.		
10030100100	100 x 300 mm	PVC (500 my)	42	42 u
10030100200	100 x 300 mm	PVC Espumado (2 mm)	36	36 u

Segmentador para arca baixa

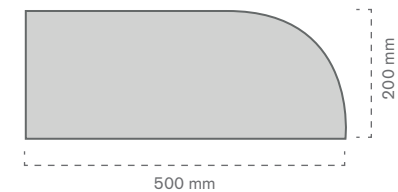

Segmentador de arca baixa personalizável a uma ou duas faces. Este modelo fixa-se à arca através das nossas pinças transparentes adesivas "T".

Ref.	Medidas	Mat.		
10030100300	500 x 200 mm	PVC (500 my)	52	52 u

Segmentador para arca baixa

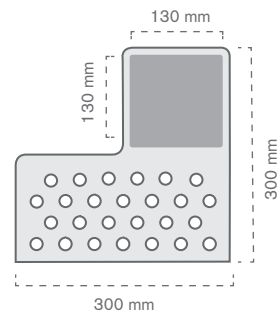

Segmentador para arca baixa personalizável com rótulo. Este modelo fixa-se à arca com as nossas bases transparentes para separadores.

Ref.	Medidas	Mat.		
10030100400	300 x 300 mm	PMMA TTE (3 mm)	36	36 u

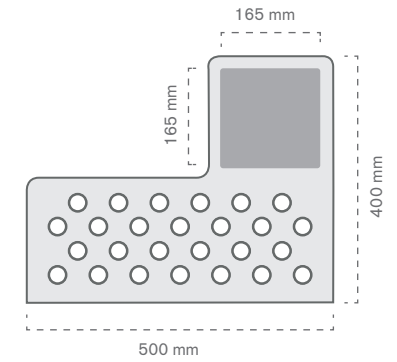

Segmentador para arca baixa. Fixa-se com os nossos pés transparentes para separadores. Personalizável com rótulo.

Ref.	Medidas	Mat.		
10030100500	500 x 400 mm	PMMA TTE (3 mm)	18	18 u

192 Segmentadores

Segmentador para arca baixa

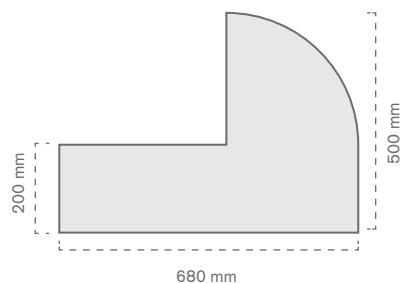

Segmentador para arca baixa personalizável com rótulo. Este modelo fixa-se à arca com as nossas bases transparentes para separadores.

Ref.	Medidas	Mat.		
10030100600	680 x 500 mm	PMMA TTE (3 mm)	8	8 u

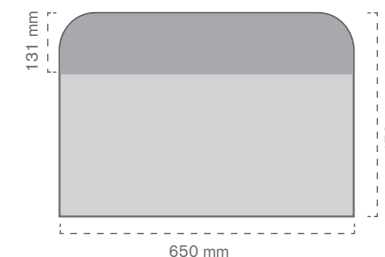

Segmentador para arca baixa. Fixa-se com os nossos pés transparentes para separadores. Personalizável com rótulo.

Ref.	Medidas	Mat.		
10030100700	650 x 450 mm	PMMA TTE (3 mm)	9	9 u

Segmentador para arca baixa

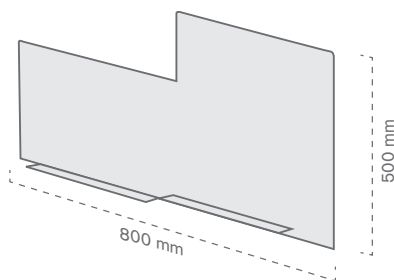

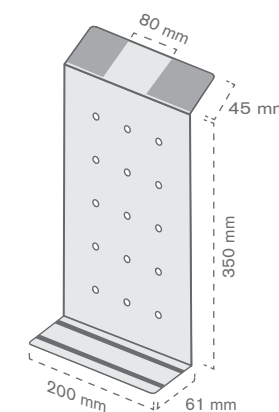

Separador de acrílico de alta resistência. Este modelo tem uma base que favorece o equilíbrio, sendo possível personalizá-lo e rotulá-lo.

Ref.	Medidas	Mat.	 	
			10	10 u
10030100800	800 x 105 x 500 mm	PMMA TTE (5 mm)		



Suporte com íman flexível. Este modelo incorpora um porta preço inclinado na parte superior, assim como duas setas que indicam a posição do produto.

Ref.	Medidas		Mat.	 	
	Geral	Mensagem		10	10 u
10030100900	200 x 61 x 382 mm	80 x 42 mm	Plástico		

194 Segmentadores

Segmentador para arca baixa

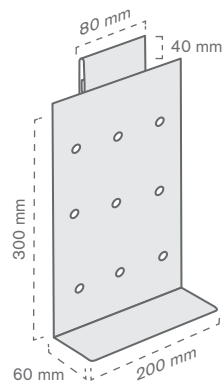

Suporte flexível. Este modelo incorpora um porta preço na parte superior, permitindo assim comunicar informação relevante para o cliente.

Ref.	Medidas		Mat.	🛒	📄
	Geral	Mensagem			
10030101000	200 x 60 x 340 mm	80 x 40 mm	Plástico	24	24 u

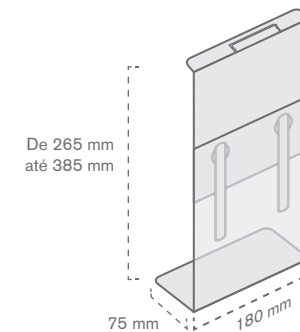

Segmentador flexível e **regulável**. Este modelo permite adaptar a altura do mesmo à arca de acordo com as necessidades de exposição, podendo incorporar uma mensagem ou display na sua parte superior.

Ref.	Medidas		Mat.	🛒	📄
	Geral	Mensagem			
10030101100	180 x 75 x 265/385 mm		Plástico	10	10 u

Segmentador **escada**

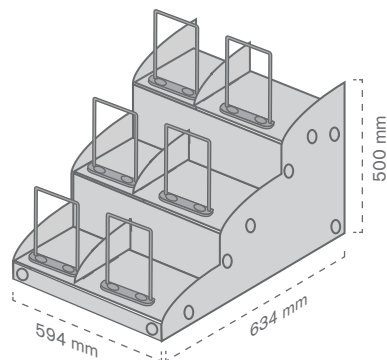

Segmentador de produto em forma de escada. Este modelo permite segmentar e classificar a exposição de artigos, sendo especialmente indicado para a exibição de pizzas.

Ref.	Medidas	Mat.	Cor		
10030101200	594 x 634 x 500 mm	PP Celular (5 mm)	PRETO	1	1 u

Segmentador para **vitrine**

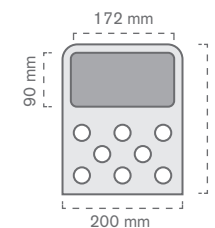

Segmentador para vitrine personalizável por meio de rotação a uma ou duas faces. Este modelo fixa-se na arca com as nossas bases transparentes para separadores.

Ref.	Medidas	Mat.		
10030101300	200 x 250 mm	PMMA TTE (3 mm)	30	30 u

196 Segmentadores

Segmentador para **vitrine**

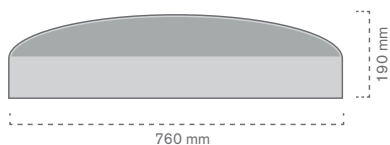



Segmentador de vitrine personalizável a uma ou duas faces. Este modelo aplica-se na arca com as nossas bases transparentes para separadores.

Ref.	Medidas	Mat.		
10030101400	760 x 190 mm	PMMA TTE (3 mm)	16	16 u

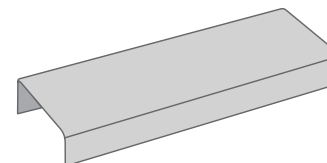
Falseador para **vitrine**



Falseador de acrílico para vitrine. Este modelo pode ser rotulado e personalizado através de mensagens e desenhos escolhidos.

Ref.	Medidas	Mat.		
10030101500	200 x 950 x 70 mm	PMMA TTE (5mm)	8	8 u
10030101600	200 x 700 x 70 mm	PMMA TTE (5 mm)	12	12 u

Complementos para segmentadores

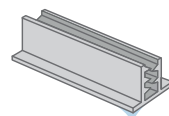
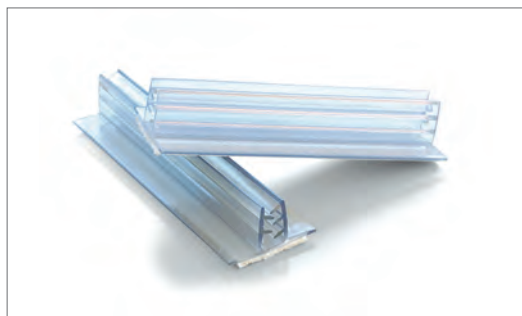



Ref.	Medidas	Mat.		
10050100500	76 x 13 mm	PVC TTE	100	100 u
10050100600	25 x 13 mm	PVC TTE	100	100 u

Pinça adesiva T.

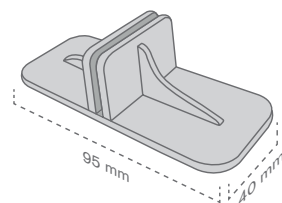
Permite a colocação de sinalizadores até 3 mm. de espessura. Tem adesivo espuma e permite a personalização no seu comprimento.



Ref.	Medidas	Mat.		
10050100200	95 x 40 mm	PC TTE	25	25 u

Base TTE para separadores.

Base especialmente indicada para artigos de 3 mm. de espessura.

