



**WAKE UP
YOUR PRODUCT.**
PLV CREATE, AMBIENT & PLACEMENT



Expositores de produto

242 Expositores de produto

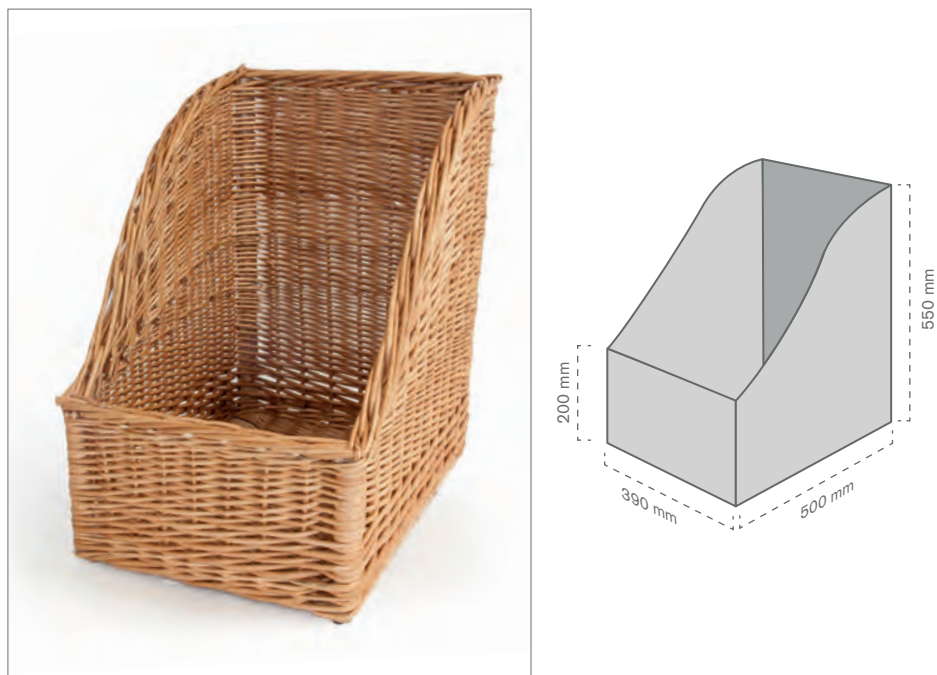
Cesto de vime modelo XL



Cesto de vime natural com cunha tamanho XL. Ideal para exposição em hotelaria, proporcionando um toque rústico e artesanal ao produto.

Ref.	Medidas	Mat.		
10040500100	390 x 500 x 550 mm	Vime	1	1 u

Cesto de vime modelo L

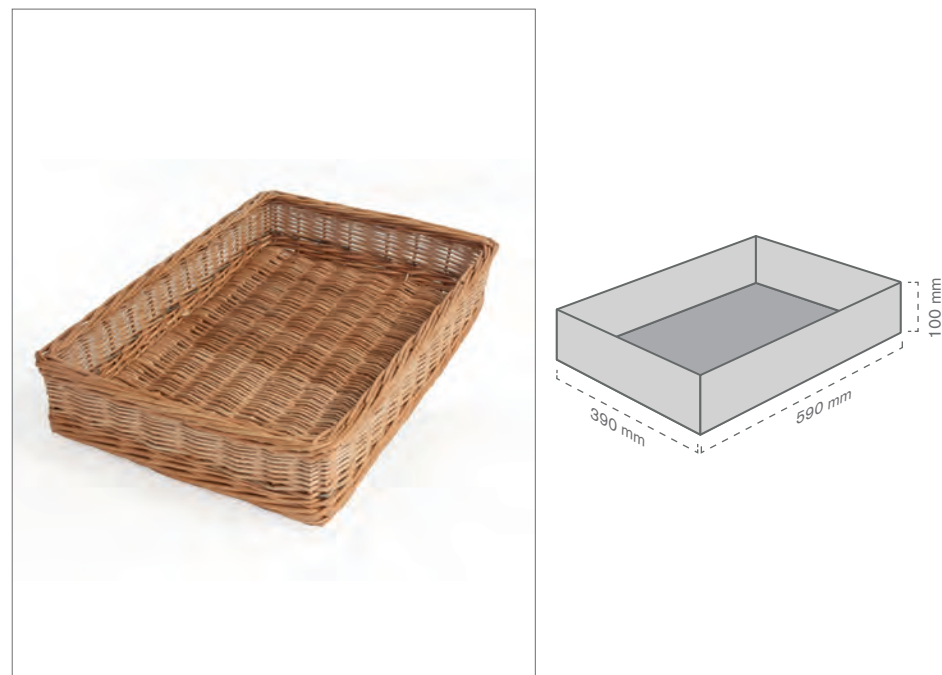



Cesto de vime natural tamanho L. Ideal para exposição em hotelaria, proporcionando um toque rústico e artesanal ao produto.

Ref.	Medidas	Mat.		
10040500200	390 x 590 x 100 mm	Vime	5	5 u

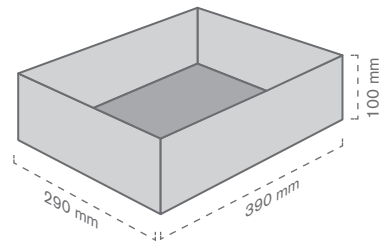
Cesto de vime modelo M



Cesto de vime natural tamanho M. Ideal para exposição em hotelaria, proporcionando um toque rústico e artesanal ao produto.

Ref.	Medidas	Mat.		
10040500300	290 x 390 x 100 mm	Vime	5	5 u

Cesto de vime com cunha modelo M

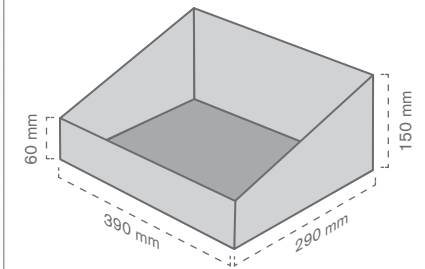

Cesto de vime natural com cunha tamanho M. Ideal para exposição em hotelaria, proporcionando um toque rústico e artesanal ao produto.

Ref.	Medidas	Mat.		
10040500400	390 x 290 x 150 mm	Vime	5	5 u

244 Expositores de produto

Expositor de **degustação**



Expositor de degustação desenhado para secções de charcutaria, produtos gourmet e/ou frutaria. Inclui guardanapeiro, paliteiro e balde de lixo.

Ref.	Medidas	Mat.	Cor		
10040500600	350 x 350 x 1315 mm	Metal	PRETO	1	1 u

Expositor **de mesa** de **cross selling**

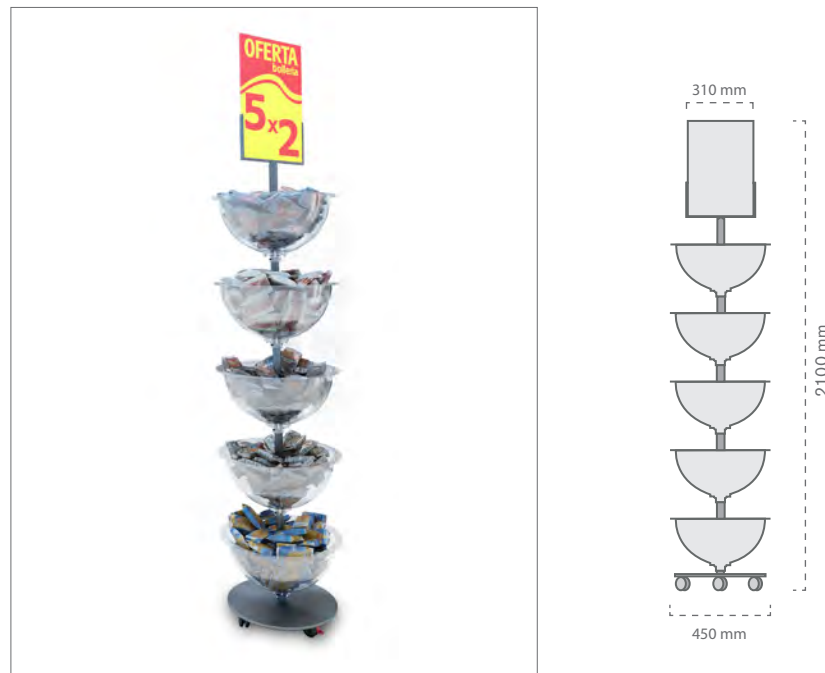

Expositor para produtos a granel. A sua estrutura composta por diversas cúpulas permite a disposição de diversos artigos a granel. As cúpulas são reguláveis em altura, permitindo adaptar a sua posição.

Ref.	Medidas	Mat.	Cor		
10040501700	450 x 450 x 2100 mm	Metal	PRETO	1	1 u

Expositor de parede para cross selling

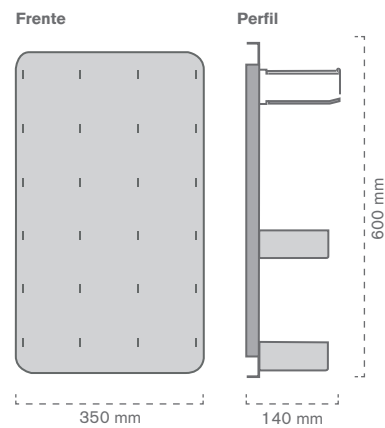

Expositor de cross selling adaptável a topos promocionais, paredes e colunas de corredores ou linear de caixas. Contém ranhuras no painel traseiro para alterar os acessórios porta produtos.

Ref.	Medidas	Mat.	Cor		
10040501600	350 x 140 x 600 mm	Metal	PRETO	1	1 u

Disponível em outras cores mediante pedido.

Expositor de sacos ECO

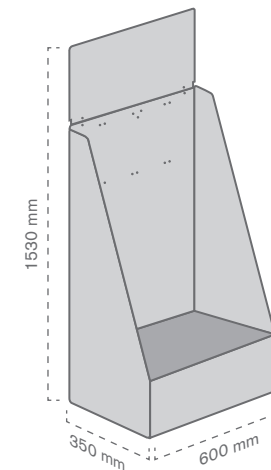

Expositor de polipropileno, especialmente indicado para a exposição de sacos ecológicos no ponto de venda.

Ref.	Medidas	Mat.		
10040501500	600 x 350 x 1530 mm	PP Celular (5 mm)	1	1 u

246 Expositores de produto

Expositor de **pequeno eletrodoméstico**

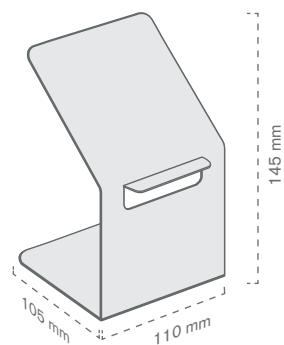

Expositor de pequeno produto, especialmente indicado para a exibição de pequenos eletrodomésticos como rádio, despertadores, telemóveis e relógios, entre outros.

Ref.	Medidas	Mat.		
10040501800	110 x 105 x 145 mm	PMMA TTE (3 mm)	6	12 u

Expositor de **pequeno eletrodoméstico**

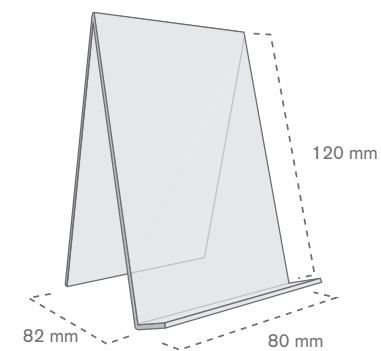

Expositor de pequeno produto, especialmente indicado para a exibição de smartphone e tablet.

Ref.	Medidas	Mat.		
10040509800	80 x 82 x 120 mm	PMMA TTE (3 mm)	6	12 u

Expositor **pequeno produto**

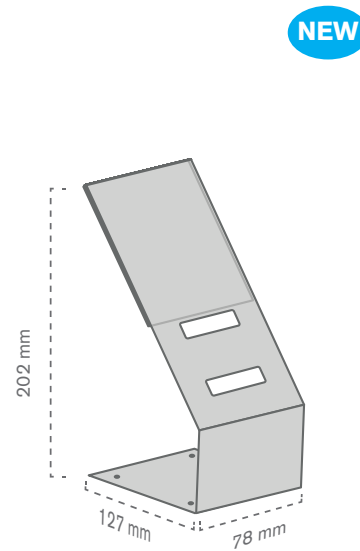

Expositor de pequeno produto, especialmente indicado para relógios.

Ref.	Medidas	Mat.		
10040509700	78 x 127 x 202 mm	PMMA TTE (3 mm)	10	10 u

Expositor de **pequeno produto** para linear

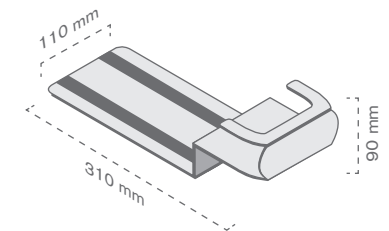

Expositor com imã desenhado para a exibição de produtos no ponto de venda. O seu material converte-o num elemento resistente, sendo possível personalizar com vinil a parte frontal.

Ref.	Medidas	Mat.		
10040504000	110 x 310 x 90 mm	PMMA TTE (3 mm)	10	10 u

Desenho não incluído

248 Expositores de produto

Expositor **inclinado**

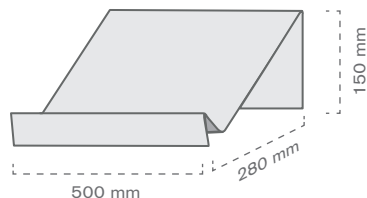

Expositor de acrílico especialmente indicado para inclinar os produtos expostos nas prateleiras inferiores, permitindo assim uma visibilidade adequada e favorável.

Ref.	Medidas	Mat.		
10040504100	500 x 280 x 150 mm	PMMA TTE (5 mm)	6	6 u

Expositor **Slim box**

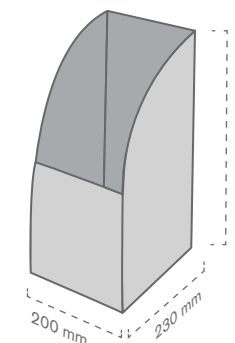

Expositor recipiente de produto. Este modelo está desenhado para reunir e exibir produtos, especialmente aqueles que têm uma forma alargada, facilitando a organização no linear.

Ref.	Medidas	Mat.		
10040504200	200 x 230 x 500 mm	PP Celular (3,5 mm)	5	5 u

Pódio

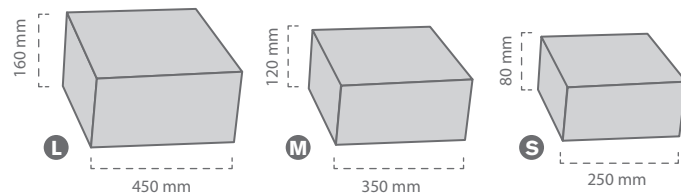

Mod.	Ref.	Medidas	Mat.	Cor		
L	10040502800	450 x 450 x 160 mm	Metal	PRETO	1	1 u
M	10040503100	350 x 350 x 120 mm	Metal	PRETO	1	1 u
S	10040503400	250 x 250 x 80 mm	Metal	PRETO	1	1 u

Disponível em outras cores mediante pedido.

Expositor Ponte

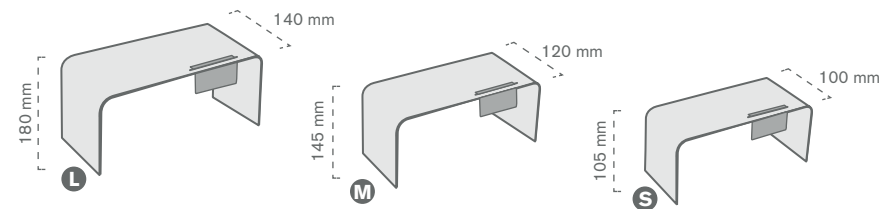

Mod.	Ref.	Medidas		Mat.	Cor		
		Expositor	Portaprecio				
L	10040501900	290 x 140 x 180 mm	53 x 37 mm	PMMA (5 mm)	TTE	4	4 u
L	10040502100	290 x 140 x 180 mm	53 x 37 mm	PMMA (5 mm)	BCO	4	4 u
M	10040502200	255 x 120 x 145 mm	53 x 37 mm	PMMA (5 mm)	TTE	4	4 u
M	10040502400	255 x 120 x 145 mm	53 x 37 mm	PMMA (5 mm)	BCO	4	4 u
S	10040502500	220 x 100 x 105 mm	53 x 37 mm	PMMA (5 mm)	TTE	4	4 u
S	10040502700	220 x 100 x 105 mm	53 x 37 mm	PMMA (5 mm)	BCO	4	4 u

250 Expositores de produto

Expositor **Ponte**



NEW

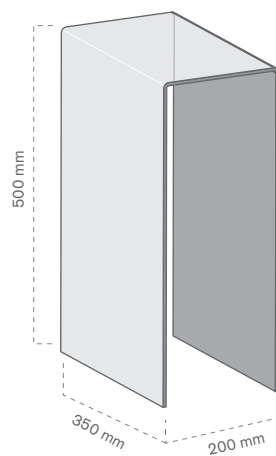

Ref.	Medidas	Mat.	Cor		
10040509900	500 x 350 x 200 mm	PMMA (5 mm)	TTE	4	4 u

Expositor **Ponte**



NEW

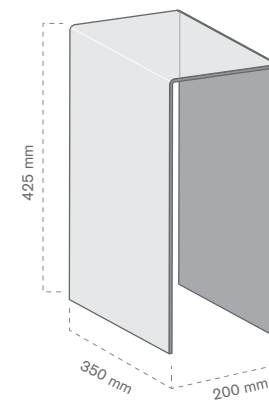

Ref.	Medidas	Mat.	Cor		
10040510000	450 x 350 x 200 mm	PMMA (5 mm)	TTE	4	4 u

Expositor modular **Professional**

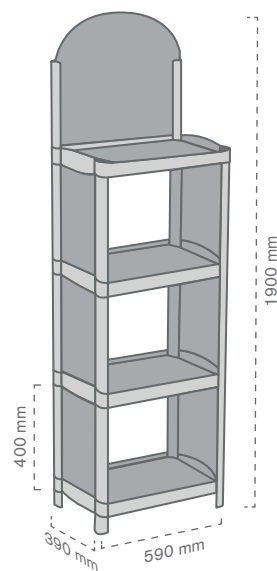

Contém 3 módulos, servindo de prateleiras para a organização e disposição de produtos em loja. Além disso, é possível personalizar a sua parte superior e lateral. Aguenta entre 30-35 Kgs por prateleira

Ref.	Medidas	Mat.	Cor		
10040506800	590 x 390 x 1900 mm	PS/ABS	VERMELHO	1	1 u
10040506900	590 x 390 x 1900 mm	PS/ABS	PRETO	1	1 u
10040507000	590 x 390 x 1900 mm	PS/ABS	BCO	1	1 u
Ref.	Descrição	Mat.	Color		
10040507600	Personalização	PVC espumado	BCO	1	1 u

Expositor modular **Desk Promoter**

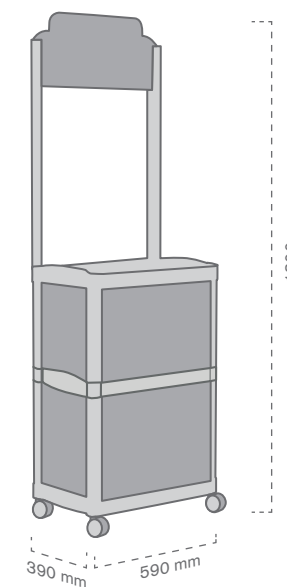

Expositor móvel que pode ser usado como mesa no ponto de venda. Este modelo é possível de personalizar na parte frontal e lateral, aguentando entre 30 a 35Kgs por prateleira.



Ref.	Medidas	Mat.	Cor		
10040507100	590 x 390 x 1800 mm	PS/ABS	PRETO	1	1 u
10040507200	590 x 390 x 1800 mm	PS/ABS	BCO	1	1 u
Ref.	Descrição	Mat.	Cor		
10040507600	Personalização	PVC espumado	BCO	1	1 u

252 Expositores de produto

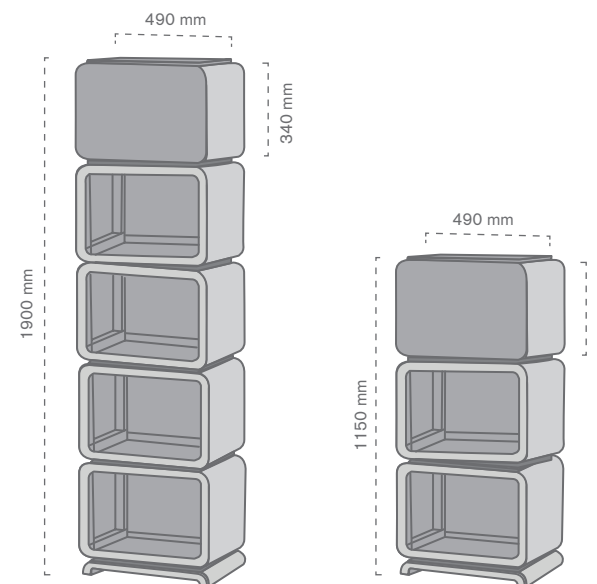
Expositor modular **Smarttower**



Expositor auto-montável. Este modelo adapta-se a todo o tipo de necessidades, sendo possível utilizá-lo como mesa ou expositor. É personalizável, aguentando até 25Kg por prateleira (sem rodar).

Ref.	Mat.	Módulos	Cor		
10040505500	PS/ABS	3	BCO	1	1 u
10040505600	PS/ABS	3	PRETO	1	1 u
10040505900	PS/ABS	5	BCO	1	1 u
10040506000	PS/ABS	5	PRETO	1	1 u

Acessórios para expositor modular **Smartower**



Com estes acessórios poderá decorar, dar forma e luz ao seu expositor.
 A: Bandeja / B: Painel decorativo / C: Vinil impresso / D: Porta lâmpadas

Ref.	Medidas	Mat.	Cor		
A 10040506500	420 x 300 x 20 mm	PS/ABS	BCO	1	1 u
A 10040506600	420 x 300 x 20 mm	PS/ABS	PRETO	1	1 u
B 10040507300	483 x 323 x 2 mm	PVC Espumado	BCO	1	1 u
B 10040507400	483 x 323 x 1 mm	PET-G	BCO	1	1 u
C 10040508400	340 x 300 mm (X2)	Vinil	BCO	1	1 u
D 10040506700	483 x 323 x 2 mm	PVC Espumado	BCO	1	1 u

Expositor **Box**

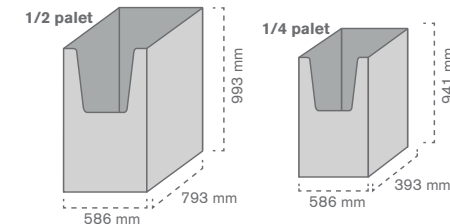

Cor/Referência				Medidas	Mat.		
186 C	347 C	BCO	PRETO				
10040500700	10040500800	10040500900	10040501000	586 x 793 x 993 mm	PP Celular (3,5 mm)	2	2 u
10040501100	10040501200	10040501300	10040501400	586 x 393 x 941 mm	PP Celular (3,5 mm)	2	2 u

